



P-5 WASH LIGHT

P-5 WHITE

P-5 TUNABLE WHITE



P-5 series dimensions

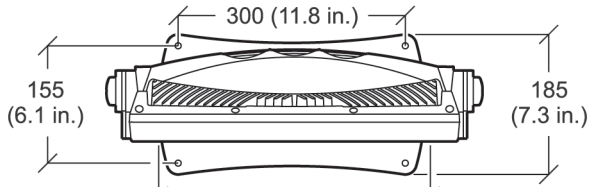
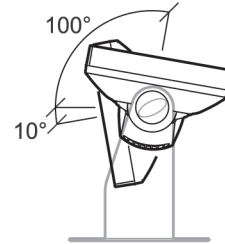
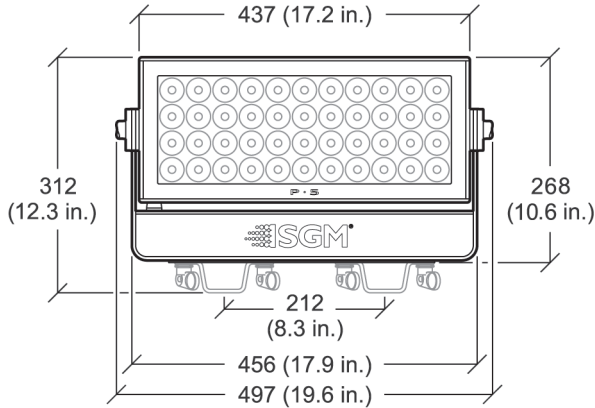
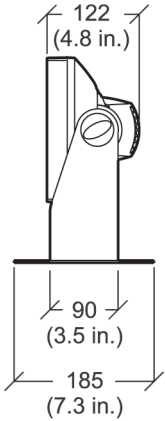

*Measurements in millimetres
and inches (in brackets).
Drawing not to scale.*

P-5 WASH LIGHT USER MANUAL

© 2015 SGM®. Information subject to change without notice. SGM and all affiliated companies disclaim liability for any injury, damage, direct or indirect loss, consequential or economic loss or any other loss occasioned by the use of, inability to use or reliance on the information contained in this manual.

The SGM logo, the SGM name and all other trademarks in this document pertaining to services or products by SGM or its affiliates and subsidiaries are trademarks owned or licensed by SGM or its affiliates or subsidiaries.

The original edition of this document is in English. All other language editions are translations of the original edition.

This edition applies to firmware version **2.43** or later.

Ver. H

Contents

P-5 series dimensions	2
Safety information	7
Overview	10
Parts identification and terminology	11
Preparing for installation	12
Installing the P-5	13
Connecting AC Power	15
Configuring the fixture	17
<i>Configuring the fixture using an Android device via RFID</i>	<i>17</i>
<i>SGM Tool App for Android.....</i>	<i>18</i>
<i>Getting fixture information using Android and RFID</i>	<i>18</i>
<i>Setting a DMX address and mode using Android and RFID</i>	<i>18</i>
<i>Programming a sequence using Android and RFID</i>	<i>19</i>
<i>Master/Slave configuration</i>	<i>19</i>
Setting a static color manually	19
Using stand-alone operation	20

Connecting to a DMX control device	21
<i>Enabling the wireless cone antenna receiver</i>	21
<i>Attaching the CRMX™ wireless receiver</i>	22
Configuring the fixture for DMX control	23
<i>About DMX</i>	23
<i>Setting the DMX address</i>	23
<i>Setting the DMX mode</i>	24
<i>Full Color Calibration and Color Temperature Correction (P-5 only)</i>	26
Fixture personality settings	27
<i>Setting the dimming curve</i>	27
<i>Flipping the OLED display</i>	27
<i>Setting the OLED display saver</i>	27
<i>Setting the fan mode</i>	28
<i>Setting the LED refresh rate (frequency)</i>	28
Service	29
<i>Changing lens module</i>	29
<i>Upgrading the firmware</i>	32
<i>Cleaning</i>	32
<i>Support hotline</i>	32

DMX protocols	33
<i>P-5 DMX Protocols</i>	33
<i>P-5 W DMX Protocols</i>	42
<i>P-5 TW DMX Protocols</i>	45
Control menu	50
Fixtures and accessories	60
<i>Included items</i>	60
<i>Ordering information</i>	60
User's notes	62

Safety information



WARNING! Read the safety precautions in this section before unpacking, installing, powering or operating this product.

The P-5 series luminaries are multi-environmental fixtures with an IP-rating of 65, intended for professional use only. They are not suitable for household use. **Impropre a l'usage domestique.**

Review the following safety precautions carefully before installing or operating the fixture. This fixture must be installed in accordance with the applicable installation code by a person familiar with the construction and operation of the fixture and the hazards involved. **Ce produit doit être installé selon le code d'installation pertinent, par une personne qui connaît bien le produit et son fonctionnement ainsi que les risques inhérent.**

Preventing electric shock



WARNING! Risk of electric shock.

- Always power off/unplug the fixture before removing any covers.
- Ensure that the power is turned off when connecting the fixture to the AC mains supply.
- Ensure that the fixture is electrically connected to earth (ground).
- Do not apply power if the fixture is in any way damaged.
- Do not immerse the fixture in water or liquid.

Preventing burns and fire



WARNING! Take measures to prevent burns and fire.

- Install in a location that prevents accidental contact with the fixture.
- Install only in a well-ventilated space.
- Install at least 0.3 m (12 in.) away from objects to be illuminated.
- Install only in accordance with applicable building codes.
- Ensure a minimum clearance of 0.1 m (4 in.) around the cooling fans.
- Do not paint, cover or modify the fixture.
- Keep all flammable materials away from the fixture.
- Allow the fixture to cool for 15 minutes after operation, before touching it.

CAUTION: *Exterior surface temperature after 5 min. operation = 45 °C (113 °F). Steady state = 68 °C (154 °F).*

Avoid personal injury



WARNING! Take measure to prevent personal injury.

- Do not look directly at the light source from close range.
- Take precautions to prevent injury due to falls when working at height.
- For permanent installation, ensure that the fixture is securely fastened to a load-bearing surface with suitable corrosion-resistant hardware.
- For temporary installation with clamps, ensure that the quarter-turn fasteners are turned fully and secured with a suitable safety cable. The cable must be approved for a safe working load (SWL) of 10 times the weight of the fixture, and it must have a minimum gauge of 3 mm.

Overview

P-5, P-5 W (white) and P-5 TW (tunable white) luminaries are DMX-controllable, low-profile, IP65-rated, rectangular, LED wash lights. The standard P-5 offers full RGBW color mixing, color temperature control and incorporate 44 10 W RGBW. The P-5 W is similar, but exclusively incorporating cool white emitting LEDs.

The P-5 TW offers the ability to adjust white color temperature between 2200K and 5300K by utilizing four shades of white LED: 2200K, 3000K, 4000K and 5300K. The P-5's all provide built-in wireless DMX support, stand-alone programs, dimming, and a lamp life expectancy of 50,000 hours*. The P-5's also offer a variation of beam angles with 15°, 21° or 43° interchangeable lenses.

This manual covers installation, use and maintenance of the P-5. All documentation is also available from the SGM web-site: <http://www.sgmlight.com>

* At 70% of luminous output under the manufacturer's test conditions.

Parts identification and terminology

- A 44 x 10 W LEDs
- B Base
- C Safety wire eyelet
- D Cooling fans
- E Tilt lock
- F DMX in and out
- G Wireless antenna socket
- H OLED display
- I Control panel
- J Power connections
- K Tilt lock

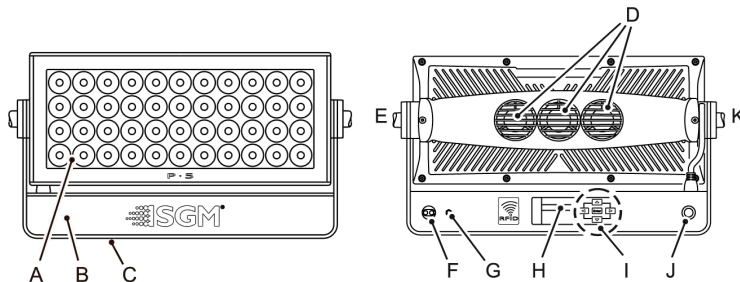

Preparing for installation

Unpack the fixture and inspect it to ensure that it has not been damaged during transport.

The P-5 is shipped with two quarter-turn brackets, that can be used to mount the fixture at elevation, and a CRMX™ wireless antenna.

The fixture is IP65-rated, and is designed for use in wet locations. This means that it is protected from:

- Dust, to the degree that dust cannot enter the fixture in sufficient quantities as to interfere with its operation.
- Lower pressure jets of water from any direction.

When selecting a location for the fixture, ensure that:

- It is situated away from public thoroughfares and protected from contact with people.
- It is not immersed in water or exposed to high-pressure water jets.
- It has adequate ventilation.

Installing the P-5

The P-5 may be installed in any orientation, but if installed horizontally with a downward beam-angle, water can potentially pool in the fan wells. Under normal operation the moisture will evaporate. However, in locations with high rainfall, you may wish to fabricate a rain shield above the fixture, or modify the position and orientation of the fixture to minimize pooling.

For permanent installation on the ground, remove the rubber feet from the floor stand/base. Fasten securely through the resulting holes with four 6 mm (1/4 in.) corrosion-resistant mechanical fasteners suitable for the location.

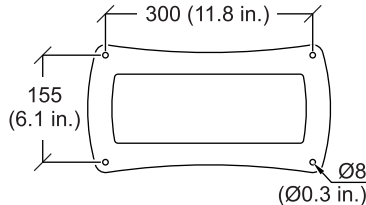

Dimensions in millimeters and inches.

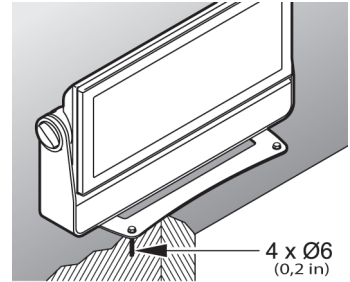

Two quarter-turn brackets are supplied with the fixture if it is to be flown above the ground. Remove the floor stand/base and rig the P-5 to a support truss or structure using the supplied brackets and suitable clamps.



Fasten a safety cable (not shown) between the support structure and the attachment point on the fixture. The safety cable must be able to bear at least 10 times the weight of the fixture.

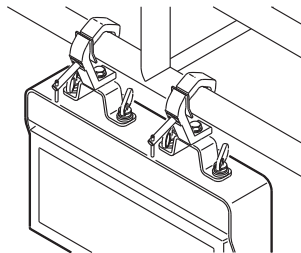

WARNING! Always secure an elevated P-5 with a safety cable as backup.

The fixture can be tilted from 0° - 190°. To adjust the tilt angle, loosen the two tilt screws, one of each side of the fixture, tilt the fixture to the angle required and re-tighten the screws.

CAUTION: If the fixture has been operating, always allow it to cool for 15 minutes before handling.

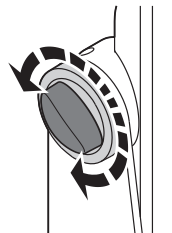

Connecting AC Power

The P-5 can operate on any 208–240 V, 50/60 Hz AC mains power supply. It draws approximately 2 amps at full power.

For permanent installation, have a qualified electrician wire the mains cable directly to a suitable branch circuit. The junction's ingress protection (IP) rating must be suitable for the location.

For temporary installation, the mains cable may be fitted with a grounded connector intended for exterior use.

The power cable color coding is given in Table 1-1.

- Connect the black wire to live
- Connect the white wire to neutral
- Connect the green/yellow wire to ground (earth)



<i>Wire</i>	<i>Color</i>	<i>Symbol</i>	<i>Conductor</i>
	Black	L	live
	White	N	neutral
	green/yellow	\perp or \oplus	ground (earth)

Table 1-1

When installing standard type C circuit breakers there will be no limitations due to the fixture in-rush current. Due to the nominal current of the fixture, ensure that no more than:

- 4 fixtures are connected through the same type C, 10A circuit breaker.
- 7 fixtures are connected through the same type C, 16A circuit breaker.

For assistance with alternative configurations, contact your SGM representative.

The fixture must be grounded/earthed and be able to be isolated from AC power. The AC power supply must incorporate a fuse or circuit breaker for fault protection.

After connecting the P-5 to power, run the on-board test, using the “Test→Automated test” menu, to ensure that the fixture and each LED are functioning correctly. See “Control menu” on page 50.

CAUTION: *Do not open the fixture to replace the supplied power cable, or connect the fixture to an electrical dimmer system, as this can damage it.*

Configuring the fixture

Set up the fixture using the control panel and OLED display at the base of the fixture.

Navigate the menus and options using the arrow buttons and select items using the Enter button. The options available are listed in “Control menu” on page 50.

After powering the P-5 on, the display shows the currently selected operating mode and other information.

A - Operational mode (Quick color, stand-alone or DMX mode)

B - DMX address

C - External data indicator (if DMX control is active)

D - External data protocol (CRMTM or DMX)

The fixture is set by default to be controlled in DMX mode.

Configuring the fixture using an Android device via RFID

P-5 fixtures can also be configured wirelessly, via RFID, using the SGM Tool app installed on an Android device that has NFC support, App available in the GoogleTM Play Store (ISO 15693 and ISO 18000-3 mode 1 compatible, operating on 13.56 MHz \pm 7k Hz carrier frequency).

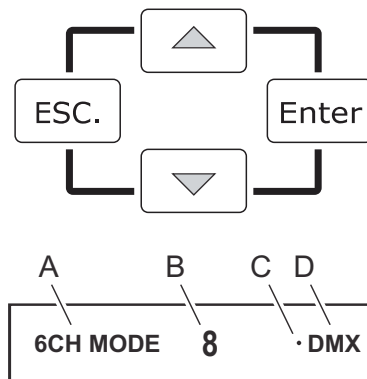

SGM Tool App for Android

The SGM tool application features the ability to, readout product information, setting DMX address, setting DMX mode and program the internal sequences. All functions can be accessed, changed and stored without having the fixture powered on.

Overview by tabs:

[INFORMATION] Product name, DMX address, DMX mode, Running hours, Serial number

[SET DMX ADDRESS] DMX address, Fixture size (DMX footprint), Fixture type, Fixture mode, Auto increase

[SEQUENCER] Color sliders, Scene time, Fade time, Previous-/Add-/Next-/Delete scene, Memory 1, Memory 2, Memory 3, Set as start up, Scene X of X.

First make sure the RFID/NFC is enabled on your device, then open the application and you are ready to scan a fixture.

Getting fixture information using Android and RFID

1. Scan fixture
2. Informations about the fixture is shown including:
 - Product name/type
 - DMX address and DMX mode
 - Running hours and serial number

Setting a DMX address and mode using Android and RFID

1. Scan fixture or press the menu button on the Android device and choose “Goto DMX addressing”.
2. Go to tab [SET DMX ADDRESS]
3. Select Fixture type, Mode and whichever you want to Auto increase the address for the next fixture
4. When all settings is correct, transfer/store the settings to the fixture by holding the device close to the fixtures RFID, when the screen goes green and a sound is played, the settings is transferred and stored.

Programming a sequence using Android and RFID

1. Scan fixture or press the menu button on the Android device and choose “Goto sequencer”.
2. Choose the scene to change, or delete all existing/default scenes to start a new sequence.
3. Set the desired color values for the scene.
4. Set the fade and wait time for the scene.
5. Choose “Add scene” or “previous/next” and repeat from step 2.
6. When all scenes has been changed/added select in which memory to store the sequence (1,2 or 3)
7. Choose if the sequence should start automatically on startup, if this function is enabled the sequence will automatically start after the fixture is power-cycled (and every time the fixture is power-cycled). To stop the stand-alone sequence, go to “Manual →Stop program”. (This will also set the fixture in DMX mode)
8. Transfer/store the sequence in the fixture by holding the device close to the fixtures RFID, when a sound is played, the settings is transferred and stored.

Master/Slave configuration

You can set a P-5 fixture to operate as master fixture to another P-5 fixture (which then becomes a slave fixture), or an entire group of P-5 fixtures (which then becomes slave fixtures). The assigned slave fixture(s) will mimic the settings of the master fixture. Use the “Manual→Master/Slave” menu to set your fixture as master fixture or slave fixture.

NB! Not all product types have RFID/NFC. Not all product types features internal sequences.

Setting a static color manually

The fixture can be configured to display a predefined and static color (or white color, depending on the P-5 model) using the “Manual→Quick color” menus (see “Control menu” on page 50).

Note that whenever the “Manual→Quick color” settings are changed, the fixture will be set by default to automatically start in quick color mode whenever it is powered on. This can be reset using the “Settings→Startup mode→Select startup mode” (see “Control menu” on page 50).

Using stand-alone operation

Stand-alone operation is where the fixture is not connected to a control device, but is preprogrammed with a series of up to 24 scenes, that play continuously in a loop. Up to three stand-alone programs can be defined and run from the menus, and one of the programs can be set to run by default whenever the fixture is started.

Each of the three available stand-alone programs contains 24 user-definable scenes, each scene with its own RGBW (or white) and shutter settings. Each scene has a definable fade-in time, for the transition from one color (or white) to the next, and a wait (static) time, each of up to 999 minutes and 59 seconds in duration. To define a stand-alone program, use the “Manual→Editor” menus (see “Control menu” on page 50).

Stand-alone mode at fixture startup is enabled using the “Settings→Startup mode→Select startup mode→Standalone” menu. The program to be run is selected using “Settings→Startup mode→Startup program” menu (see “Control menu” on page 50) for a description of the menus). The chosen program will run its length cyclically whenever the fixture is powered on.

A program can be run at any time by selecting it using the “Manual→Run program” menu.

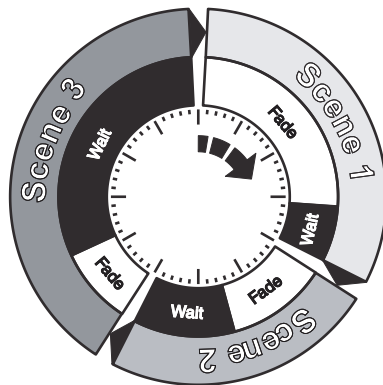

Connecting to a DMX control device

The fixture is controllable using a DMX control device and it can be connected using either a DMX cable or via the P-5's built-in wireless receiver system.

If using a cabled DMX system, connect the DMX in cable (with male 5-pin XLR plug) and out cable (with female 5-pin XLR plug) to the DMX data link. Terminate the DMX out cable of the last fixture in the data link. For outdoor installations, use only IP-rated XLR connectors suitable for outdoor use.

Enabling the wireless cone antenna receiver

The wireless cone antenna is factory mounted and is recommended for short-range wireless operation. For long range wireless operation, the CRMX™ wireless receiver is recommended (see details below).

Before you enable the wireless cone antenna, ensure that there is no DMX cable connected to the fixture.

Use the “Settings→Wireless DMX→Enable” menu to enable wireless DMX and the “Settings→Wireless DMX→Wireless LED Status” to confirm that a data connection has been established. The wireless cone antenna operates at a frequency of 2.4 GHz, so ensure that the DMX transmitter is configured to operate in this range.

It is mandatory that the cone antenna is connected to the fixture when using cabled DMX or when the long-range antenna isn't connected, to maintain IP rating.

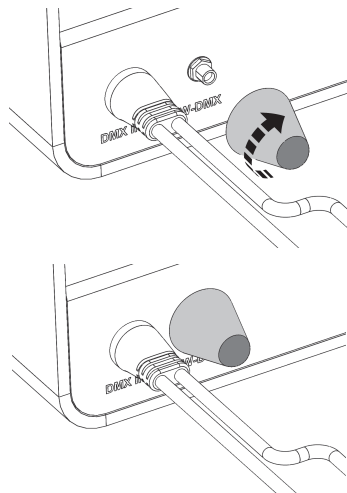

Attaching the CRMX™ wireless receiver

The CRMX™ wireless receiver (antenna) is an included accessory and is recommended for long-range wireless operation.

Before you connect the wireless receiver, ensure that there is no DMX cable connected to the fixture. For long-range operation, replace the factory default cone antenna with the supplied wireless CRMX™ antenna to the connector on the back of the fixture.

Use the “Settings→Wireless DMX→Enable” menu to activate wireless DMX and the “Settings→Wireless DMX→Wireless LED Status” to confirm that a data connection has been established. CRMX™ operates at a frequency of 2.4 GHz, so ensure that the DMX transmitter is configured to operate in this range.

NB! Fixtures with serial number 02Dxxxxxxx are fitted with WirelessSolution receiver unless upgraded to LumenRadio.

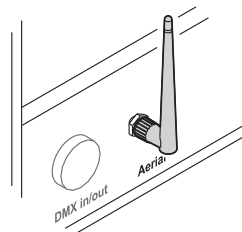
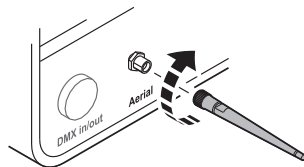

Configuring the fixture for DMX control

About DMX

The P-5 can be controlled using signals sent by a DMX controller on a number of channels (which varies depending on the DMX mode that has been set).

The first channel used to receive data from a DMX control device is known as the DMX start address. Each P-5 must have a DMX start address set. For example, if a P-5 has a DMX address of 10 and it is in 3-channel DMX mode, then it uses channels 10, 11, and 12. The following fixture in the DMX chain could then be set to a DMX address of 13. If two or more DMX fixtures of the same type have the same DMX address, then they will mimic each other's behaviour. Incorrect settings will result in unpredictable responses to the lighting controller.

Setting the DMX address

The DMX address can be seen on the main screen. To change the address setting, press the up arrow to increase the address, or the down arrow to decrease the setting. When the desired address is displayed, press Enter to save the setting. For your convenience, the suggested DMX address of the next fixture is displayed to the right. Note that channel spacing is determined by the DMX mode.

See the "DMX protocols" on page 33 for specific DMX control values.

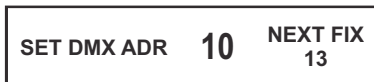

Setting the DMX mode

Using the “DMX mode” menu available from the control panel, specify the DMX mode that provides the fixture controls that you require, confirm chosen mode by pressing ‘Enter’. (*FCC, Full Color Calibrated)

P-5 DMX modes	FCC*	Function
3	Yes	Control for: Red, Green, Blue, White is automatically mixed in.
4	No	Control for: Red, Green, Blue, White. (RAW)
6	Yes	Control for: Red, Green, Blue, intensity, shutter / shutter effects & CTC control. (auto white)
6	No	Control for: Red, Green, Blue, White, intensity, shutter / shutter effects. (RAW)
8	No	Control for: Red, Green, Blue, White. (RAW)
9	No	Control for: Red, Green, Blue, White + Intensity. Colors 16-Bit. (RAW)
10	No	Control for: Red, Green, Blue, White + Intensity. All 16-Bit. (RAW)

P-5 TW DMX modes	Function
2	Control for: Intensity & white temperature correction (2200k-5300K).
4	Control for: 2200K-, 3000K-, 4000K-, and 5300K LED's.
6	Control for: Intensity, shutter / shutter effects & white temperature correction (2200k-5300K).
8	Control for: 2200K-, 3000K-, 4000K-, and 5300K LED's. 16-Bit.

P-5 W DMX modes	Function
1	Control for: Intensity
2	Control for: Intensity & shutter / shutter effects.
2	Control for: Intensity. 16-Bit.

Full Color Calibration and Color Temperature Correction (P-5 only)

All channel modes except 3 Channel Mode RGB and 6 Channel RGB + CTC: Lets you choose between raw or white-calibrated color (6500K default) via the Control Menu (“Settings→White Calibrated”)

3 Channel Mode RGB: Features full color calibration (irrespective of current color setting) when you mix 2 or 3 colors to ensure uniform color mixing between products. Adjusting 1 color does not activate full color calibration.

6 Channel Mode RGB + CTC: Features full color calibration (irrespective of current color setting) when you mix 2 or 3 colors to ensure uniform color mixing between products. Adjusting 1 color does not activate full color calibration. This mode allows you to adjust the white color temperature step less from 2000K to 10000K (when RGB is at 100%).

Enabling the CTC channel (DMX value above 5) sets the white reference, of which any color will mix towards, example:

1. CTC is set to 182 / 71,3% = 5600K (default value)
2. Green + Blue at 100% = Cyan
3. Red is added/faded to 100% = Cyan will fade to 5600K white.

If you want to be able to mix raw RGB colors without full color calibration, select the 4 Channel Mode RGBW and disregard the white color.

All channel modes except: 3 Channel Mode RGB 6 Channel Mode RGB + CTC	3 Channel Mode RGB 6 Channel Mode RGB + CTC
Choose raw or white-calibrated color (6500K default) via the Control Menu (“Settings→White Calibrated”)	Full Color Calibration

Fixture personality settings

Setting the dimming curve

The setting of the dimming curve will determine the fixture's behavior, when changing the light intensity between 0% - 100%. Linear control provides uniform adjustment throughout the control action, whereas gamma corrected dimming provides finer control at low light levels, where the eye is more sensitive to change. By default, the P-5 uses gamma corrected dimming. For uniform response, set all fixtures to the same dimming curve. To set the desired dimming curve, use the "Settings→Dimming curve" menu.

Flipping the OLED display

If the fixture is installed hanging upside down, it might be useful to flip the display so that it is easier to read. To flip the display, use the "Settings→Flip display" menu, or press the up and down buttons on the control panel at the same time.

Setting the OLED display saver

By default the OLED display dims down after a short period when the control panel is not in use, but it can also be set to turn off completely. Pressing any key will always turns on the display or restore it to normal brightness. To change the display saver, use the "Settings→Display saver" menu.

NOTE: To avoid the risk of display deterioration caused by long term use in permanent installations, it is recommended to use the "Display saver→Display off" setting.

Setting the fan mode

For operating environments where low-noise is a requirement or where the fixture will be operating in high temperatures, it is possible to adjust the default fan speed to low or high using the “Settings→Fan mode” menu.

Setting the LED refresh rate (Frequency)

When using LED lighting with cameras, flickering can occur due to incompatible frequency settings which means the LEDs and the cameras is not synchronised.

In order to avoid flickering and horizontal banding (rolling shutter) the P-5 series offers the ability to adjust the refresh rate (frequency) in order to achieve flicker-free performance.

In the P-5 menu, go to “Settings→Refresh rate”, here you are able to set the refresh rate (frequency) of the LEDs to be:

- Dimmer optimized (low frequency), flicker can occur on cameras / highest dimming resolution.
- High frequency optimized (low dimming resolution), flicker is unlikely to occur / low dimming resolution.
- Custom value, from 0,2 kHz to 72,0 kHz. Adjust to a custom frequency.

It is recommended to have the P-5 configured to run “Dimmer optimized” whenever possible to maintain the best possible dimming performance.

Does flicker or horizontal banding occur, it is likely because the P-5 is set to “Dimmer optimized” or a low custom value.

To avoid these phenomenons set the refresh rate to “High frequency optimized” or adjust the refresh rate to a custom value above 0,544929 kHz (value of “Dimmer optimized”).

When adjusting a custom value, you want to choose a frequency high enough to avoid flickering and/or horizontal banding, but low enough to maintain a good dimming performance.

Since there are differences between camera models, exposure settings etc., the optimal refresh rate settings will differ.

In order to achieve the best result, adjust the refresh rate through a preview monitor with a feed from the cameras.

Service

Apart from the lens module, there are no user-serviceable components in the fixture. Do not open the P-5, as doing so is likely to damage the ingress protection. Consult your SGM dealer if the fixture operates abnormally, is defective or otherwise in need of service or repair.

Changing lens module

To replace the lens module:

- 1 Unscrew the highlighted screws with a TX20 screwdriver.

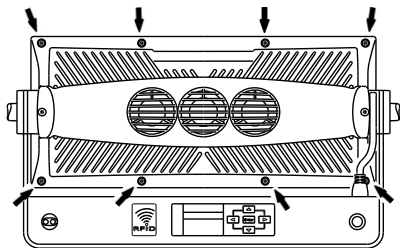

- 2 Dismantle the front and unscrew the highlighted front plugs with an Unbrako 6/HOP6 Allen key.

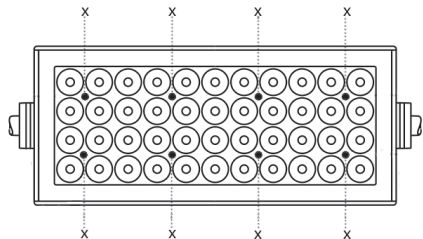

- 3 Take out the lens module.
- 4 Place the new lens on the PCB print spacers and carefully press the lens module in place.

- 5 Screw in the highlighted front plugs with an Unbrako 6/HOP6 Allen key (Nm 1,0) and place three Silica Gel bags (not included in lens kit) as shown.

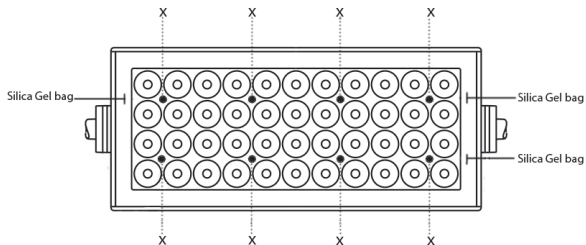

- 6 Place the sealing frame (facing upwards - see below) on top of the lens module.

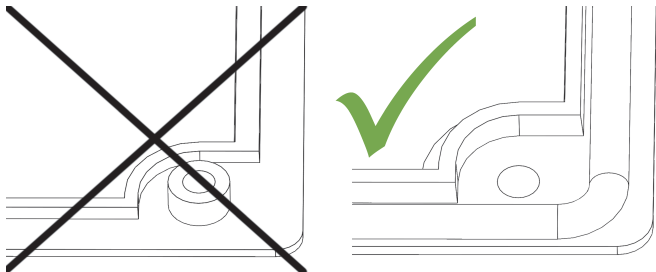

- 7 Place Front Assembly on top of the sealing frame.
- 8 Screw in the highlighted screws with a TX20 screwdriver (Nm 0,7) (see step 1).
- 9 Check that the sealing frame is evenly visible all the way around the lens module.

Upgrading the firmware

The firmware installed on the fixture can be identified using the “Info→Firmware version” menu. We recommend that you keep your fixture’s firmware up-to-date. Visit <http://www.sgmlight.com> to download the latest firmware.

To perform firmware updates, you need a Windows-based personal computer and a SGM USB 5-Pin-XLR upload cable (available from your SGM distributor).

Cleaning

To maintain optimal performance, regular cleaning is essential. Cleaning schedules will vary depending on the operating environment, and the installation should therefore be checked at frequent intervals within the first few weeks of operation to see whether cleaning is necessary. This procedure will allow you to assess cleaning requirements in your particular situation. If in doubt, consult your SGM dealer for a suitable maintenance schedule.

Clean the P-5 using a soft cloth dampened with a solution of water and a mild detergent. Do not use products that contain solvents, abrasives or caustic agents for cleaning, as they can cause damage to both hardware, cables and connectors.

Support hotline

SGM offers a 24/7 technical support hotline.

Worldwide: +45 3840 3840

US: +1 877 225-3882

DMX protocols

Configuring DMX is described “Setting the DMX mode” on page 24.

P-5 DMX Protocols

3 Channel Mode - RGB plus automatic White (Full Color Calibrated)

Channel	Name	DMX value	DMX percentage	Description	Info	Default DMX value	Fader type
1	RED	0 255	0,0% 100,0%	No RED > Maximum RED		0 (0%)	Fade
2	GREEN	0 255	0,0% 100,0%	No GREEN > Maximum GREEN		0 (0%)	Fade
3	BLUE	0 255	0,0% 100,0%	No BLUE > Maximum BLUE		0 (0%)	Fade

4 Channel Mode - RGBW (Raw mode)

Channel	Name	DMX value	DMX percentage	Description	Info	Default DMX value	Fader type
1	RED	0 255	0,0% 100,0%	No RED > Maximum RED		0 (0%)	Fade
2	GREEN	0 255	0,0% 100,0%	No GREEN > Maximum GREEN		0 (0%)	Fade
3	BLUE	0 255	0,0% 100,0%	No BLUE > Maximum BLUE		0 (0%)	Fade
4	WHITE	0 255	0,0% 100,0%	No WHITE > Maximum WHITE		0 (0%)	Fade

6 Channel Mode - RGBW, intensity & Shutter (Raw mode)

Channel	Name	DMX value	DMX percentage	Description	Info	Default DMX value	Fader type		
1	Shutter	0	7	0,0%	2,7%	Closed	10 (3,9%)	Snap	
		8	15	3,1%	5,9%	Open			
		16	151	6,3%	59,2%	Strobe			Fast > Slow
		152	175	59,6%	68,6%	Pulse - Open			Slow > Fast
		176	199	69,0%	78,0%	Pulse - Close			Slow > Fast
		200	244	78,4%	95,7%	Strobe - Random			Slow > Fast
		245	255	96,1%	100,0%	Open			
2	Intensity	0	255	0,0%	100,0%	No light > Maximum light		0 (0%)	Fade
3	RED	0	255	0,0%	100,0%	No RED > Maximum RED		0 (0%)	Fade
4	GREEN	0	255	0,0%	100,0%	No GREEN > Maximum GREEN		0 (0%)	Fade

Channel	Name	DMX value		DMX percentage		Description	Info	Default DMX value	Fader type
5	BLUE	0	255	0,0%	100,0%	No BLUE > Maximum BLUE		0 (0%)	Fade
6	WHITE	0	255	0,0%	100,0%	No WHITE > Maximum WHITE		0 (0%)	Fade

6 Channel Mode - RGB, intensity, Shutter & CTC (Full Color Calibrated)

Channel	Name	DMX value	DMX percentage	Description	Info	Default DMX value	Fader type		
1	Shutter	0	7	0,0%	2,7%	Closed	10 (3,9%)	Snap	
		8	15	3,1%	5,9%	Open			
		16	151	6,3%	59,2%	Strobe			Fast > Slow
		152	175	59,6%	68,6%	Pulse - Open			Slow > Fast
		176	199	69,0%	78,0%	Pulse - Close			Slow > Fast
		200	244	78,4%	95,7%	Strobe - Random			Slow > Fast
		245	255	96,1%	100,0%	Open			
2	Intensity	0	255	0,0%	100,0%	No light > Maximum light	0 (0%)	Fade	
3	CTC	0	4	0,0%	1,6%	No CTC (RAW)	182 (71,3%)	Fade	
		5	255	2%	100%	CTC 2000K-10000K			
4	RED	0	255	0,0%	100,0%	No RED > Maximum RED	0 (0%)	Fade	

Channel	Name	DMX value		DMX percentage		Description	Info	Default DMX value	Fader type
5	GREEN	0	255	0,0%	100,0%	No GREEN > Maximum GREEN		0 (0%)	Fade
6	BLUE	0	255	0,0%	100,0%	No BLUE > Maximum BLUE		0 (0%)	Fade

8 Channel Mode (16 bit) - RGBW

Channel	Name	DMX value	DMX percentage	Description	Info	Default DMX value	Fader type
1 2	RED	0 65535	0,0% 100,0%	No RED > Maximum RED		0 (0%)	Fade
3 4	GREEN	0 65535	0,0% 100,0%	No GREEN > Maximum GREEN		0 (0%)	Fade
5 6	BLUE	0 65535	0,0% 100,0%	No BLUE > Maximum BLUE		0 (0%)	Fade
7 8	WHITE	0 65535	0,0% 100,0%	No WHITE > Maximum WHITE		0 (0%)	Fade

9 Channel Mode (16 bit) - Intensity & RGBW

Channel	Name	DMX value	DMX percentage	Description	Info	Default DMX value	Fader type
1	Intensity	0 255	0,0% 100,0%	No light > Maximum light		0 (0%)	Fade
2 3	RED	0 65535	0,0% 100,0%	No RED > Maximum RED		0 (0%)	Fade
4 5	GREEN	0 65535	0,0% 100,0%	No GREEN > Maximum GREEN		0 (0%)	Fade
6 7	BLUE	0 65535	0,0% 100,0%	No BLUE > Maximum BLUE		0 (0%)	Fade
8 9	WHITE	0 65535	0,0% 100,0%	No WHITE > Maximum WHITE		0 (0%)	Fade

10 Channel Mode (16 bit) - Intensity & RGBW

Channel	Name	DMX value	DMX percentage	Description	Info	Default DMX value	Fader type
1 2	Intensity	0 65535	0,0% 100,0%	No light > Maximum light		0 (0%)	Fade
3 4	RED	0 65535	0,0% 100,0%	No RED > Maximum RED		0 (0%)	Fade
5 6	GREEN	0 65535	0,0% 100,0%	No GREEN > Maximum GREEN		0 (0%)	Fade
7 8	BLUE	0 65535	0,0% 100,0%	No BLUE > Maximum BLUE		0 (0%)	Fade
9 10	WHITE	0 65535	0,0% 100,0%	No WHITE > Maximum WHITE		0 (0%)	Fade

P-5 W DMX Protocols

1 Channel Mode - Intensity

Channel	Name	DMX value	DMX percentage	Description	Info	Default DMX value	Fader type
1	WHITE	0 255	0,0% 100,0%	No WHITE > Maximum WHITE		0 (0%)	Fade

2 Channel Mode - Shutter & Intensity

Channel	Name	DMX value		DMX percentage		Description	Info	Default DMX value	Fader type
1	Shutter	0	7	0,0%	2,7%	Closed		10 (3,9%)	Snap
		8	15	3,1%	5,9%	Open			
		16	151	6,3%	59,2%	Strobe	Fast > Slow		
		152	175	59,6%	68,6%	Pulse - Open	Slow > Fast		
		176	199	69,0%	78,0%	Pulse - Close	Slow > Fast		
		200	244	78,4%	95,7%	Strobe - Random	Slow > Fast		
		245	255	96,1%	100,0%	Open			
2	WHITE	0	255	0,0%	100,0%	No WHITE > Maximum WHITE		0 (0%)	Fade

2 Channel Mode (16 bit) - Intensity

Channel	Name	DMX value	DMX percentage	Description	Info	Default DMX value	Fader type
1 2	WHITE	0 65535	0,0% 100,0%	No WHITE > Maximum WHITE		0 (0%)	Fade

P-5 TW DMX Protocols

2 Channel Mode - Intensity & white temperature control

Channel	Name	DMX value		DMX percentage		Description	Info	Default DMX value	Fader type
1	Intensity	0	255	0,0%	100,0%	No light > Maximum light		0 (0%)	Fade
2	White temperature	0	255	0,0%	100,0%	2200K-5300K		0 (0%)	Fade

4 Channel Mode - White control (Raw mode)

Channel	Name	DMX value	DMX percentage	Description	Info	Default DMX value	Fader type
1	2200K WHITE	0 255	0,0% 100,0%	No WHITE > Maximum WHITE		0 (0%)	Fade
2	3000K WHITE	0 255	0,0% 100,0%	No WHITE > Maximum WHITE		0 (0%)	Fade
3	4000K WHITE	0 255	0,0% 100,0%	No WHITE > Maximum WHITE		0 (0%)	Fade
4	5300K WHITE	0 255	0,0% 100,0%	No WHITE > Maximum WHITE		0 (0%)	Fade

6 Channel Mode - White control, dimmer & shutter (Raw mode)

Channel	Name	DMX value	DMX percentage	Description	Info	Default DMX value	Fader type		
1	Shutter	0	7	0,0%	2,7%	Closed		10 (3,9%)	Snap
		8	15	3,1%	5,9%	Open		0 (0%)	
		16	151	6,3%	59,2%	Strobe	Fast > Slow	0 (0%)	
		152	175	59,6%	68,6%	Pulse - Open	Slow > Fast	0 (0%)	
		176	199	69,0%	78,0%	Pulse - Close	Slow > Fast	0 (0%)	
		200	244	78,4%	95,7%	Strobe - Random	Slow > Fast	0 (0%)	
		245	255	96,1%	100,0%	Open		0 (0%)	
2	Intensity	0	255	0,0%	100,0%	No light > Maximum light		0 (0%)	Fade
3	2200K WHITE	0	255	0,0%	100,0%	No WHITE > Maximum WHITE		0 (0%)	Fade

Channel	Name	DMX value		DMX percentage		Description	Info	Default DMX value	Fader type
4	3000K WHITE	0	255	0,0%	100,0%	No WHITE > Maximum WHITE		0 (0%)	Fade
5	4000K WHITE	0	255	0,0%	100,0%	No WHITE > Maximum WHITE		0 (0%)	Fade
6	5300K WHITE	0	255	0,0%	100,0%	No WHITE > Maximum WHITE		0 (0%)	Fade

8 Channel Mode (16 bit) - White control (Raw mode)

Channel	Name	DMX value		DMX percentage		Description	Info	Default DMX value	Fader type
1 2	2200K WHITE	0	65535	0,0%	100,0%	No WHITE > Maximum WHITE		0 (0%)	Fade
3 4	3000K WHITE	0	65535	0,0%	100,0%	No WHITE > Maximum WHITE		0 (0%)	Fade
5 6	4000 WHITE	0	65535	0,0%	100,0%	No WHITE > Maximum WHITE		0 (0%)	Fade
7 8	5300 WHITE	0	65535	0,0%	100,0%	No WHITE > Maximum WHITE		0 (0%)	Fade

Control menu

Level 1	Level 2	Level 3	Function
Mode	Select Mode	-	Select DMX mode. See “Setting the DMX mode” on page 24 for information about the features of each mode.
Info	Product Type	-	Displays product type.
	Firmware Version	-	Displays installed software version.
	Serial Number	-	Displays serial number.
	RDM ID	-	Displays RDM ID. (for use with the SGM Tool App.)
	DMX View	-	Displays received DMX levels.
	Temperatures MB: LED:	-	Displays fixture temperatures. (Mainboard and LED panel)
	Power On Time	-	Displays power on time.
	Power On Time Resettable	-	Displays power on time. (can be reset)

Level 1	Level 2	Level 3	Function
Info (continued)	LED On Time R: G: B: W:	-	Displays LED on time. (Red, Green, Blue, and White)
	LED On Time Resettable R: G: B: W:	-	Displays LED on time. (can be reset)
	Log	-	Displays recorded operating data and error codes.
	Debug	-	Service use only.
Settings	Wireless DMX	Log Off	Sends log off command to the CRMX system.
		Wireless LED	Flashing - not connected to data. Solid - connected to data.
		Enable	Enables wireless DMX operation.
		Disable	Disables wireless DMX operation.
		Wireless DMX out enable	Enables wireless DMX out operation. (DMX in via cable, DMX out via wireless)

Level 1	Level 2	Level 3	Function
Settings (continued)	Wireless DMX (continued)	Wireless DMX out disable	Disables wireless DMX out operation.
	Startup Mode	Select Startup Mode	Default operating mode when fixture is powered on: 1. Quick Color. 2. Stand-alone. 3. DMX. (factory default)
		Startup Program	Stand-alone program 1, 2, or 3. Only used if the startup mode is set to "stand-alone". 1 is default.
	Dimming Curve	Linear	Provides equal resolution dimming from 0-100%.
		Gamma Corrected	Provides high-resolution dimming at low levels.
	White Calibrated	Calibrated	Enables white calibrated color.
		Raw	Enables raw color.
	Flip Display	Disable	Selects normal control panel display.

Level 1	Level 2	Level 3	Function
Settings (continued)	Flip Display (continued)	Enable	Flips control panel display.
	Display Saver	Display Dim	Dims the OLED display when the control panel is not in use.
		Display Off	Turns off the OLED display when the control panel is not in use.
	Fan Mode	Standard	Adjust fan speed relative to internal fixture temperature.
		Silent	Low fan speed for quiet operation.
		Max Power	High fan speed for maximum cooling effect.
		Always Full Power	High fan speed with no adjustment.
	Minimum values	Min. Red (P-5)	Adjust default minimum setting (0-8000). Service use only.
		Min. Green (P-5)	
		Min. Blue (P-5)	

Level 1	Level 2	Level 3	Function
Settings (continued)	Minimum values (continued)	Min. White (P-5)	Adjust default minimum setting (0-8000). Service use only.
		Min. Line 1 (P-5 W)	
		Min. Line 2 (P-5 W)	
		Min. Line 3 (P-5 W)	
		Min. Line 4 (P-5 W)	
		Min. 3000 (P-5 TW)	
		Min. 2200 (P-5 TW)	

Level 1	Level 2	Level 3	Function
Settings (continued)	Minimum values (continued)	Min. 4000 (P-5 TW)	Adjust default minimum setting (0-8000). Service use only.
		Min. 5300 (P-5 TW)	
	RFID Write	Enable	Enables the RFID entry.
		Disable	Disable the RFID entry.
	Refresh Rate	Dimmer optimized	Set the LED's to a dimmer optimized default. (factory default) See "Setting the LED refresh rate (Frequency)" on page 28 for details.
		High frequency optimized	Set the LED's to a high frequency optimized default. See "Setting the LED refresh rate (Frequency)" on page 28 for details.
		Custom value	Set a custom frequency (refresh rate) for the LED's. See "Setting the LED refresh rate (Frequency)" on page 28 for details.

Level 1	Level 2	Level 3	Function
Settings (continued)	Factory Default		Reset the fixture to factory default settings.
	Service Pin	-	Contact your SGM dealer or SGM support to request the service pin. Service use only.
	Service Menu	-	Only accessible when service pin has been entered. Service use only.
Manual	Quick Color	Red (P-5)	Static quick color - red mix (0-255). Sets fixture to quick color startup mode.
		Green (P-5)	Static quick color - green mix (0-255). Sets fixture to quick color startup mode.
		Blue (P-5)	Static quick color - blue mix (0-255). Sets fixture to quick color startup mode.
		White (P-5/ P-5 W)	Static quick color - white mix (0-255). Sets fixture to quick color startup mode.
		2200K (P-5 TW)	Static quick color - white temperature 2200K mix (0-255). Sets fixture to quick color startup mode.

Level 1	Level 2	Level 3	Function
Manual (continued)	Quick Color (continued)	3000K (P-5 TW)	Static quick color - white temperature 3000K mix (0-255). Sets fixture to quick color startup mode.
		4000K (P-5 TW)	Static quick color - white temperature 4000K mix (0-255). Sets fixture to quick color startup mode.
		5300K (P-5 TW)	Static quick color - white temperature 5300K mix (0-255). Sets fixture to quick color startup mode.
	Run Program	1, 2, or 3	Runs internal sequence 1,2 or 3.
	Stop Program	-	Stops current running internal sequence or Quick Color.
	Master/Slave	-	Sets fixture to operate as Master or Slave fixture.
	Editor	Program	Currently selected program (1, 2, or 3).
		Scene	Currently selected scene (1-24).
		Red (P-5)	Red value in currently selected scene (0-255).
		Green (P-5)	Green value in currently selected scene (0-255).
Blue (P-5)		Blue value in currently selected scene (0-255).	

Level 1	Level 2	Level 3	Function
Manual (continued)	Editor (continued)	White (P-5 / P-5 W)	White value in currently selected scene (0-255).
		2200K (P-5 TW)	2200K white value in currently selected scene (0-255).
		3000K (P-5 TW)	3000K white value in currently selected scene (0-255).
		4000K (P-5 TW)	4000K white value in currently selected scene (0-255).
		5300 (P-5 TW)	5300K white value in currently selected scene (0-255).
		Shutter	Shutter setting in currently selected scene (0-255):
			Shutter Blackout (0-7).
			Shutter Open (8-15).
			Variable Strobe (16-151).
			Pulse Open (152-175).
			Pulse Close (176-199).
Variable Random Strobe (200-244).			
Shutter Open (245-255).			

Level 1	Level 2	Level 3	Function
Manual (continued)	Editor (continued)	Fade Time (Min.)	Fade-in (transition) time to current scene in min. (0-999).
		Fade Time (Sec.)	Fade-in (transition) time to current scene in sec. (0-59).
		Wait Time (Min.)	Wait (static) time in current scene in min. (0-999).
		Wait Time (Sec.)	Wait (static) time in current scene in sec. (0-59).
Test	Off	-	Stops test sequence execution.
	Automated Test	-	Initiates a self-test sequence.
	Burn-in Test (30 min.)	-	Service use only.
	Display Test	-	Service use only.

Fixtures and accessories

Included items

Floor stand (including screws)
Two Omega brackets
Wireless CRMX antenna
Wireless Cone antenna (mounted from factory)
User manual
Neoprene pouch

Ordering information

P-5 Wash Light (43°)	Order no: 80030517
P-5 Wash Light (21°)	Order no: 80030515
P-5 Wash Light (15°)	Order no: 80030518
P-5 Lens Kit (43°)	Order no: 83061118
P-5 Lens Kit (21°)	Order no: 83061117
P-5 Lens Kit (15°)	Order no: 83061116
BBC-2 Dual Bracket	Order no: 83060603
BBC-4 Quad Bracket	Order no: 83060604
Floor Stand for P, Q, and X series with 1/4-turn fasteners	Order no: 83060610
Accessory Holder (P-series)	Order no: 83061119
Barn door 4-way	Order no: 83061120
Barn door 8-way	Order no: 83061121
Color frame, P-5, X-5 & Q-7 Series (for Accessory holder)	Order no: 83061122
SGM USB uploader cable	Order no: 83062011
Flight case (for 4 fixtures - P-5/Q-7/X-5)	Order no: 82051501

APPROVALS AND CERTIFICATIONS

Certified to CSA Std. C22.2 No. 166
Conforms to UL Std. 1573
Conforms to 2006/95/EC: Low Voltage Directive
Conforms to 2011/65/EU: RoHS2 Directive



The information in this document is subject to change without notice

User's notes



SGM A/S · Sommervej 23 · 8210 Aarhus V · Denmark
Tel +45 70 20 74 00 · info@sgmlight.com · www.sgmlight.com